

阅读申明

- 1.本站收集的数据手册和产品资料都来自互联网，版权归原作者所有。如读者和版权方有任何异议请及时告之，我们将妥善解决。
- 2.本站提供的中文数据手册是英文数据手册的中文翻译，其目的是协助用户阅读，该译文无法自动跟随原稿更新，同时也可能存在翻译上的不当。建议读者以英文原稿为参考以便获得更精准的信息。
- 3.本站提供的产品资料，来自厂商的技术支持或者使用者的心得体会等，其内容可能存在描述上的差异，建议读者做出适当判断。
- 4.如需与我们联系，请发邮件到marketing@iczoom.com，主题请标有“数据手册”字样。

Read Statement

1. The datasheets and other product information on the site are all from network reference or other public materials, and the copyright belongs to the original author and original published source. If readers and copyright owners have any objections, please contact us and we will deal with it in a timely manner.
2. The Chinese datasheets provided on the website is a Chinese translation of the English datasheets. Its purpose is for reader's learning exchange only and do not involve commercial purposes. The translation cannot be automatically updated with the original manuscript, and there may also be improper translations. Readers are advised to use the English manuscript as a reference for more accurate information.
3. All product information provided on the website refer to solutions from manufacturers' technical support or users the contents may have differences in description, and readers are advised to take the original article as the standard.
4. If you have any questions, please contact us at marketing@iczoom.com and mark the subject with "Datasheets" .

PNP Silicon Digital Transistor

- Switching circuit, inverter, interface circuit, driver circuit
- Built in bias resistor ($R_1 = 4.7 \text{ k}\Omega$)
- BCR169S / U: Two internally isolated transistors with good matching in one multichip package
- BCR169S / U: For orientation in reel see package information below

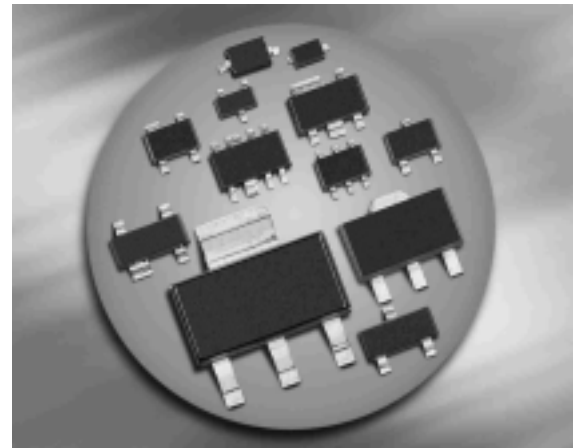
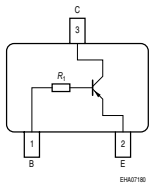
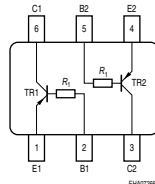
**BCR169/F/L3
BCR169T/W**

BCR169S/U

| Type | Marking | Pin Configuration | | | | | | Package |
|----------|---------|-------------------|------|------|------|------|------|----------|
| | | 1=B | 2=E | 3=C | - | - | - | |
| BCR169 | WSs | 1=B | 2=E | 3=C | - | - | - | SOT23 |
| BCR169F | WSs | 1=B | 2=E | 3=C | - | - | - | TSFP-3 |
| BCR169L3 | WS | 1=B | 2=E | 3=C | - | - | - | TSLP-3-4 |
| BCR169S | WSs | 1=E1 | 2=B1 | 3=C2 | 4=E2 | 5=B2 | 6=C1 | SOT363 |
| BCR169T | WS | 1=B | 2=E | 3=C | - | - | - | SC75 |
| BCR169U | WSs | 1=E1 | 2=B1 | 3=C2 | 4=E2 | 5=B2 | 6=C1 | SC74 |
| BCR169W | WSs | 1=B | 2=E | 3=C | - | - | - | SOT323 |

Maximum Ratings

| Parameter | Symbol | Value | Unit |
|--|--------------|-------------|------|
| Collector-emitter voltage | V_{CEO} | 50 | V |
| Collector-base voltage | V_{CBO} | 50 | |
| Input forward voltage | $V_{i(fwd)}$ | 30 | |
| Input reverse voltage | $V_{i(rev)}$ | 5 | |
| Collector current | I_C | 100 | mA |
| Total power dissipation | P_{tot} | | mW |
| BCR169, $T_S \leq 102^\circ\text{C}$ | | | |
| BCR169F, $T_S \leq 128^\circ\text{C}$ | | | |
| BCR169L3, $T_S \leq 135^\circ\text{C}$ | | | |
| BCR169S, $T_S \leq 115^\circ\text{C}$ | | | |
| BCR169T, $T_S \leq 109^\circ\text{C}$ | | | |
| BCR169U, $T_S \leq 118^\circ\text{C}$ | | | |
| BCR169W, $T_S \leq 124^\circ\text{C}$ | | | |
| Junction temperature | T_j | 150 | °C |
| Storage temperature | T_{stg} | -65 ... 150 | |

Thermal Resistance

| Parameter | Symbol | Value | Unit |
|--|------------|-------|------|
| Junction - soldering point ¹⁾ | R_{thJS} | | K/W |
| BCR169 | | | |
| BCR169F | | | |
| BCR169L3 | | | |
| BCR169S | | | |
| BCR169T | | | |
| BCR169U | | | |
| BCR169W | | | |

¹For calculation of R_{thJA} please refer to Application Note Thermal Resistance

Electrical Characteristics at $T_A = 25^\circ\text{C}$, unless otherwise specified

| Parameter | Symbol | Values | | | Unit |
|---|---------------|--------|------|------|------------|
| | | min. | typ. | max. | |
| DC Characteristics | | | | | |
| Collector-emitter breakdown voltage $I_C = 100 \mu\text{A}, I_B = 0$ | $V_{(BR)CEO}$ | 50 | - | - | V |
| Collector-base breakdown voltage $I_C = 10 \mu\text{A}, I_E = 0$ | $V_{(BR)CBO}$ | 50 | - | - | |
| Collector-base cutoff current $V_{CB} = 40 \text{ V}, I_E = 0$ | I_{CBO} | - | - | 100 | nA |
| Emitter-base cutoff current $V_{EB} = 5 \text{ V}, I_C = 0$ | I_{EBO} | - | - | 100 | nA |
| DC current gain ¹⁾ $I_C = 5 \text{ mA}, V_{CE} = 5 \text{ V}$ | h_{FE} | 120 | - | 630 | - |
| Collector-emitter saturation voltage ¹⁾ $I_C = 10 \text{ mA}, I_B = 0.5 \text{ mA}$ | V_{CEsat} | - | - | 0.3 | V |
| Input off voltage $I_C = 100 \mu\text{A}, V_{CE} = 5 \text{ V}$ | $V_{i(off)}$ | 0.4 | - | 0.8 | |
| Input on voltage $I_C = 2 \text{ mA}, V_{CE} = 0.3 \text{ V}$ | $V_{i(on)}$ | 0.5 | - | 1.1 | |
| Input resistor | R_1 | 3.2 | 4.7 | 6.2 | k Ω |
| AC Characteristics | | | | | |
| Transition frequency $I_C = 10 \text{ mA}, V_{CE} = 5 \text{ V}, f = 100 \text{ MHz}$ | f_T | - | 200 | - | MHz |
| Collector-base capacitance $V_{CB} = 10 \text{ V}, f = 1 \text{ MHz}$ | C_{cb} | - | 3 | - | pF |

¹⁾Pulse test: $t < 300 \mu\text{s}$; $D < 2\%$

DC current gain $h_{FE} = f(I_C)$

$V_{CE} = 5\text{ V}$ (common emitter configuration)

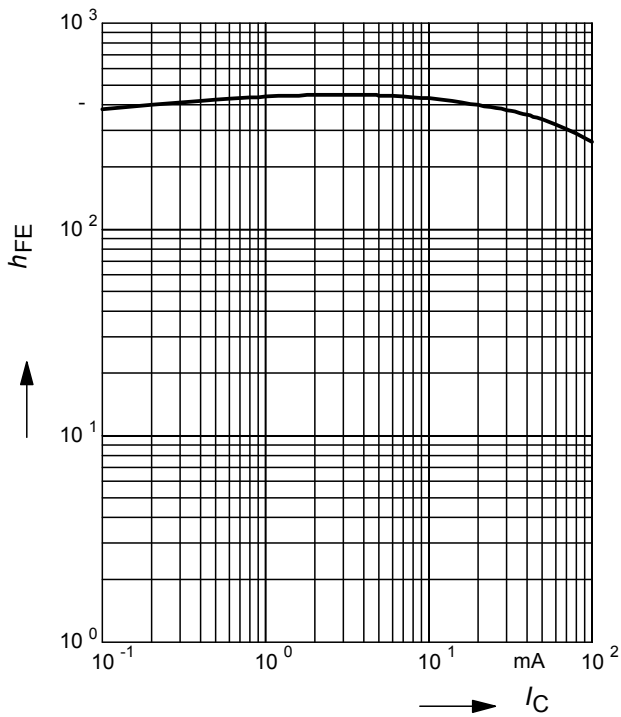

Collector-emitter saturation voltage

$V_{CEsat} = f(I_C), h_{FE} = 20$

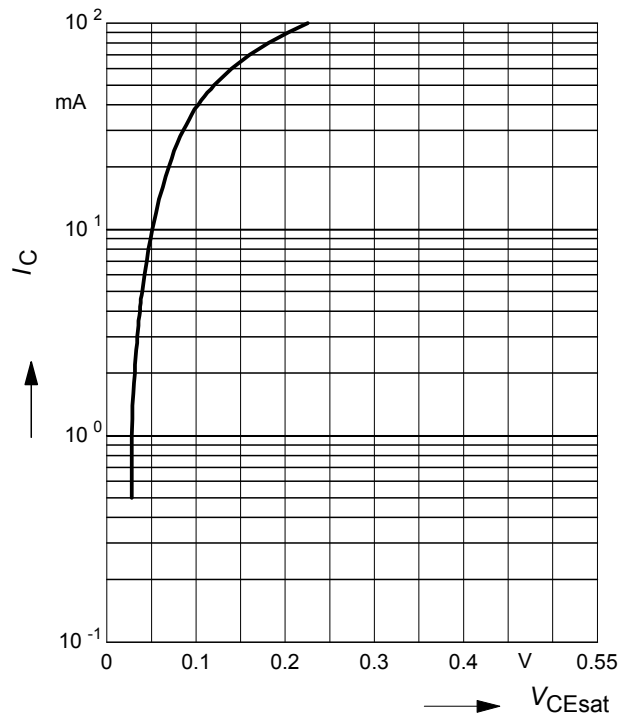

Input on Voltage $V_{i(on)} = f(I_C)$

$V_{CE} = 0.3\text{ V}$ (common emitter configuration)

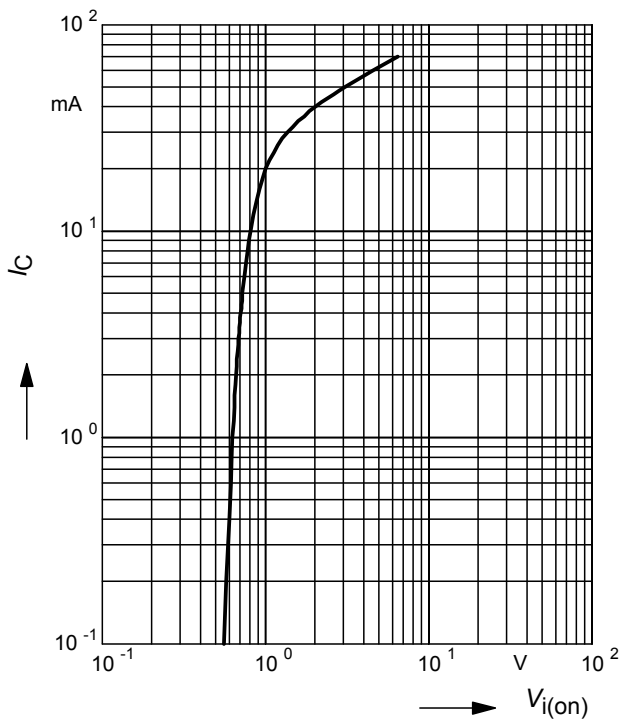

Input off voltage $V_{i(off)} = f(I_C)$

$V_{CE} = 5\text{ V}$ (common emitter configuration)

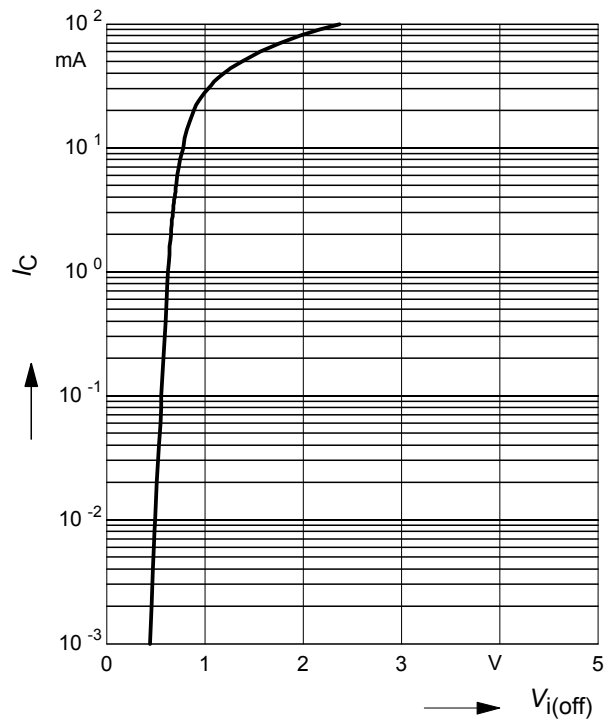

Total power dissipation $P_{tot} = f(T_S)$

BCR169

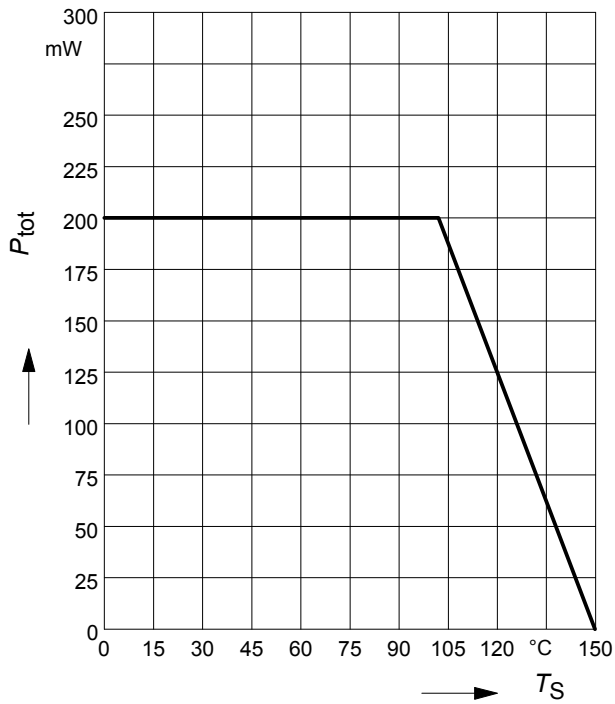

Total power dissipation $P_{tot} = f(T_S)$

BCR169F

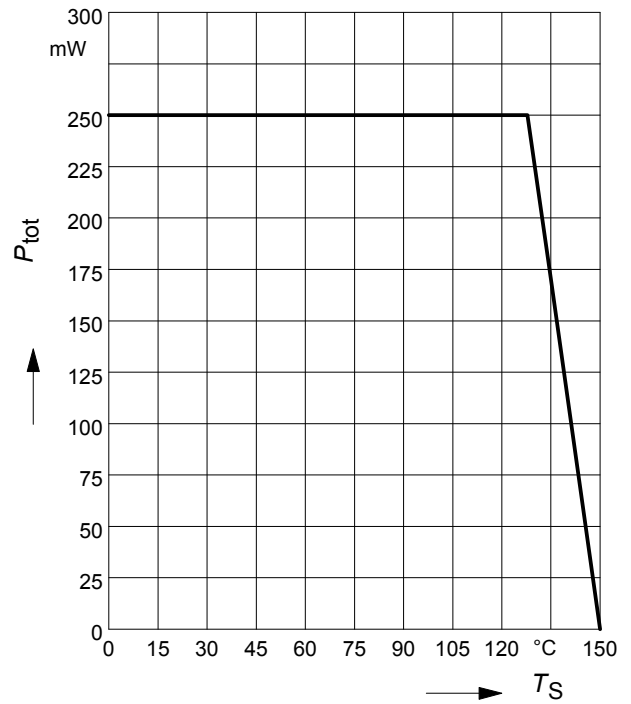

Total power dissipation $P_{tot} = f(T_S)$

BCR169L3

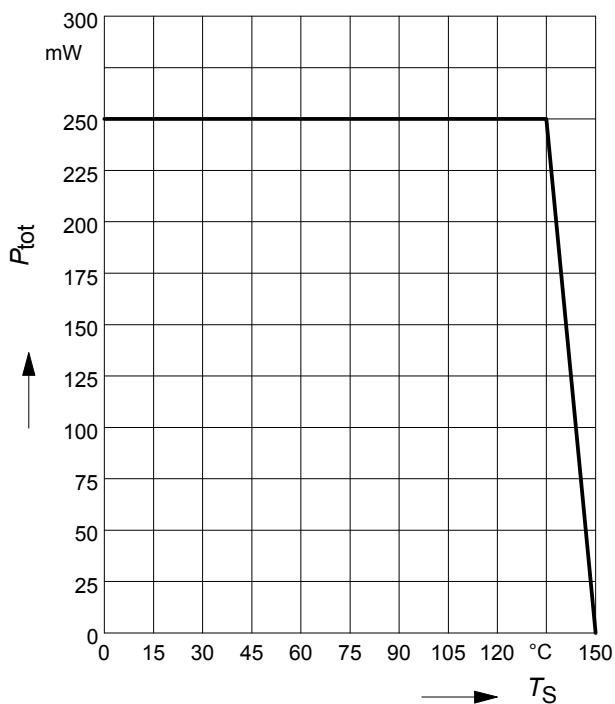

Total power dissipation $P_{tot} = f(T_S)$

BCR169S

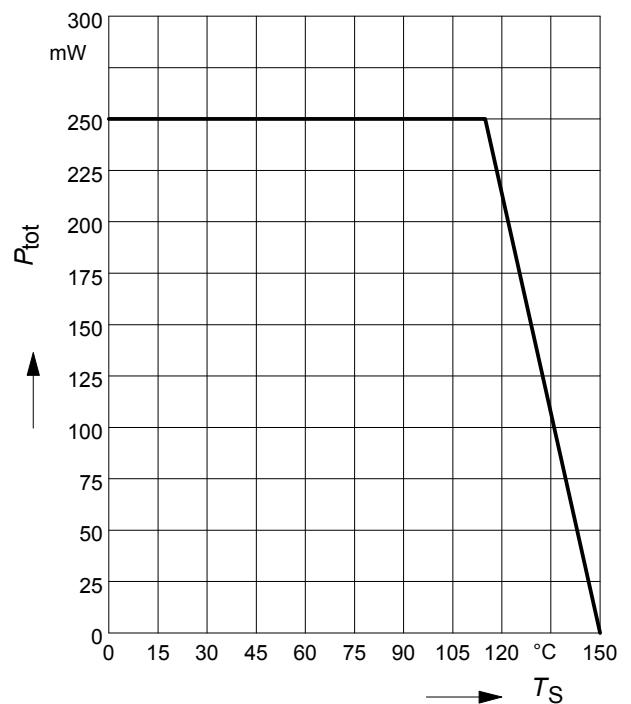

Total power dissipation $P_{\text{tot}} = f(T_S)$

BCR169T

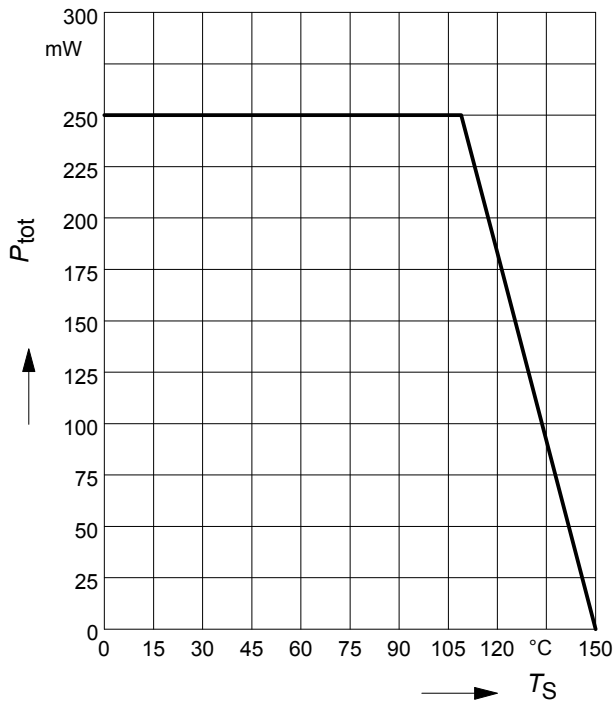

Total power dissipation $P_{\text{tot}} = f(T_S)$

BCR169U

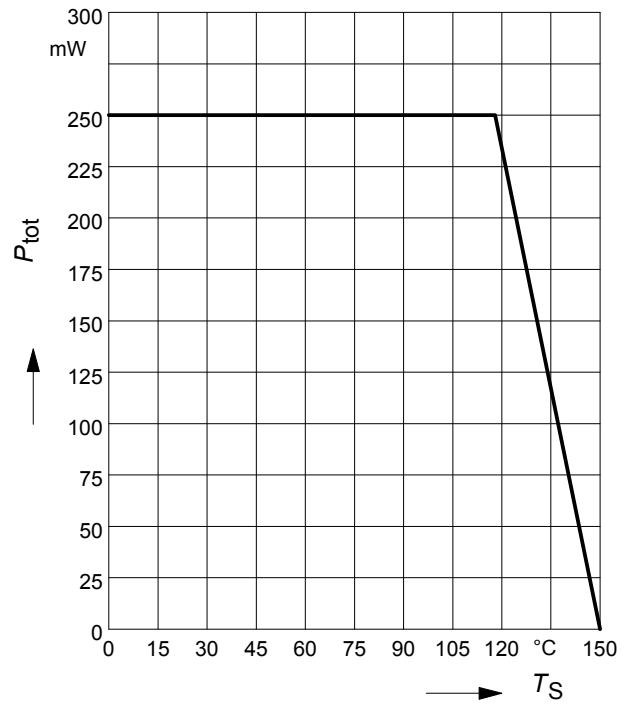

Total power dissipation $P_{\text{tot}} = f(T_S)$

BCR169W

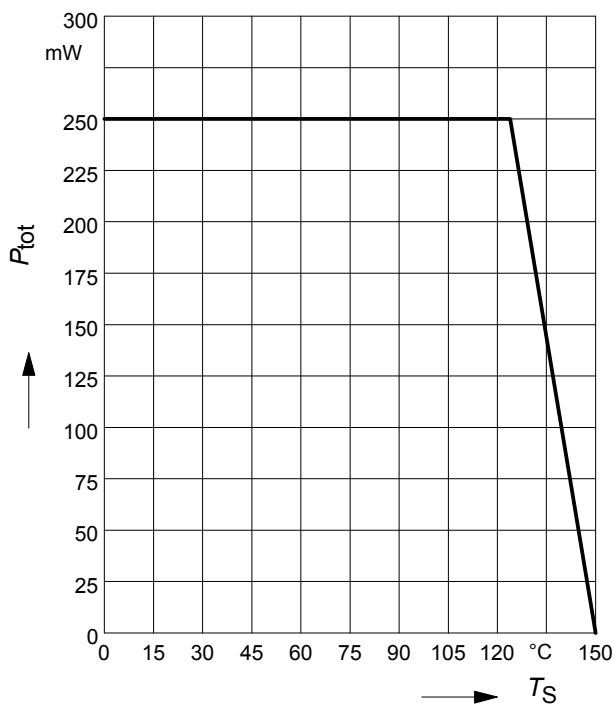

Permissible Pulse Load $R_{thJS} = f(t_p)$

BCR169

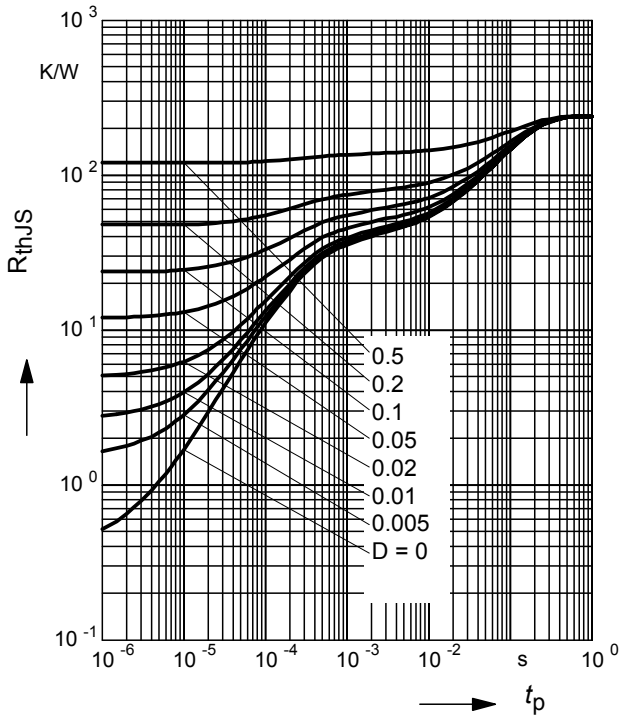

Permissible Pulse Load

$P_{totmax}/P_{totDC} = f(t_p)$

BCR169

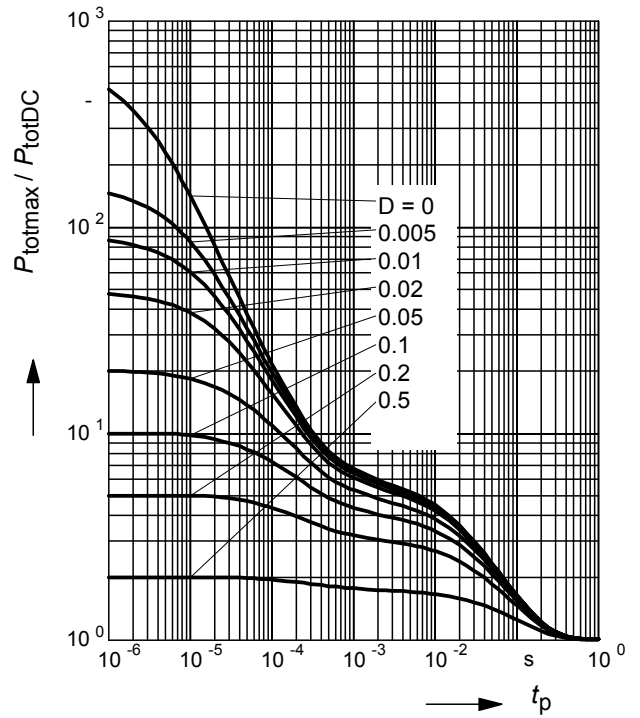

Permissible Puls Load $R_{thJS} = f(t_p)$

BCR169F

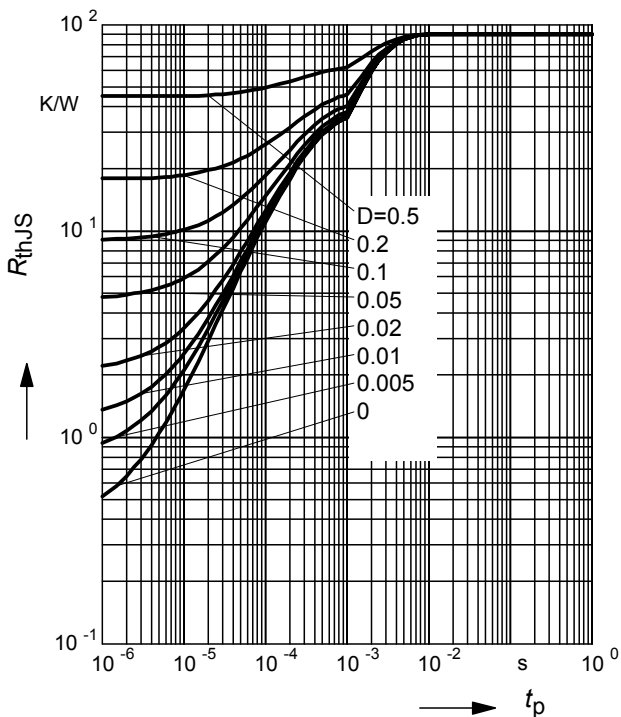

Permissible Pulse Load

$P_{totmax}/P_{totDC} = f(t_p)$

BCR169F

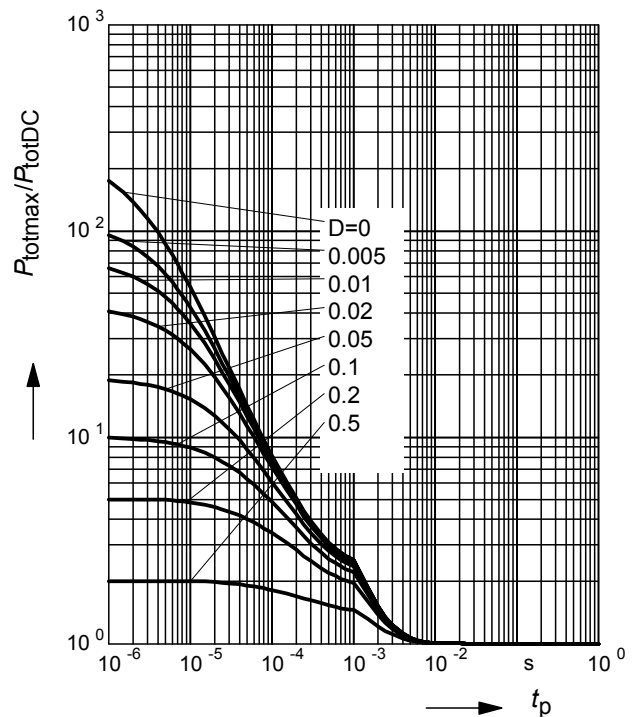

Permissible Puls Load $R_{thJS} = f(t_p)$

BCR169L3

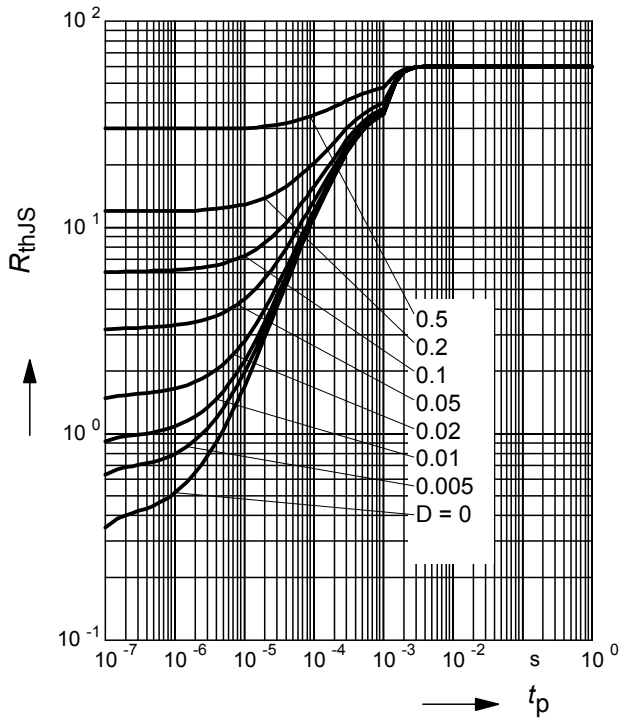

Permissible Pulse Load

$P_{totmax}/P_{totDC} = f(t_p)$

BCR169L3

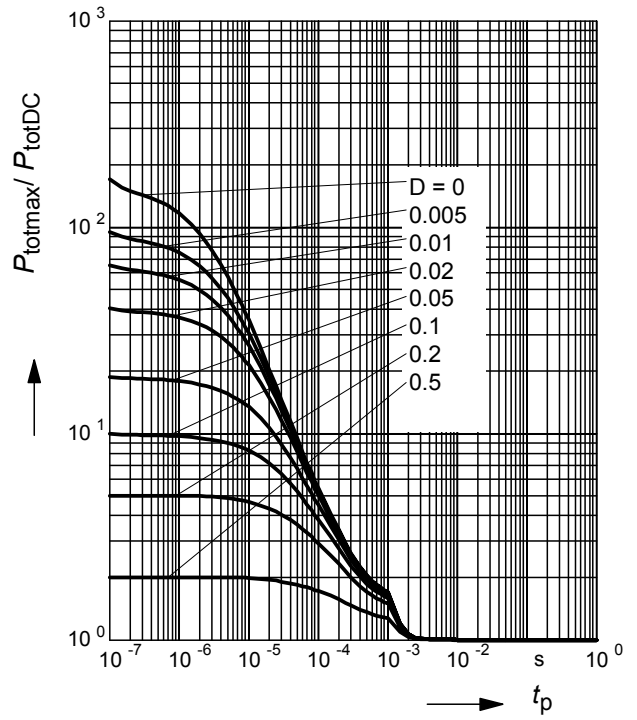

Permissible Puls Load $R_{thJS} = f(t_p)$

BCR169S

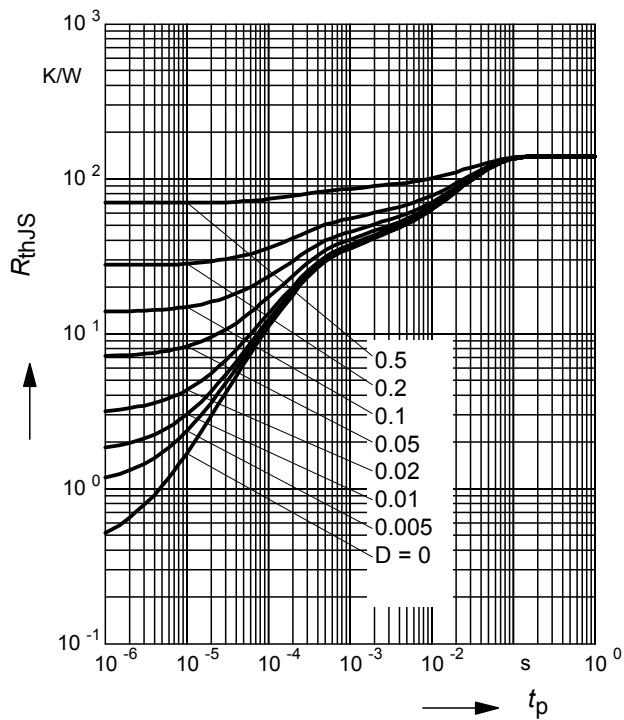

Permissible Pulse Load

$P_{totmax}/P_{totDC} = f(t_p)$

BCR169S

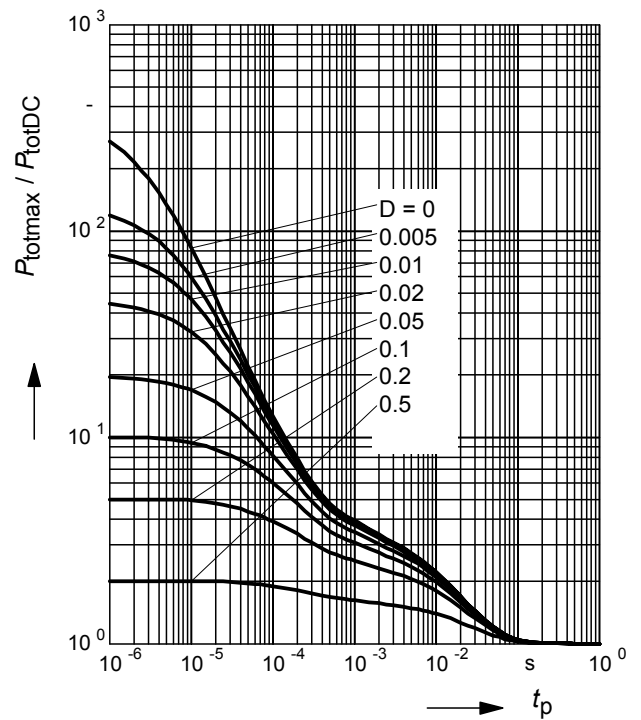

Permissible Puls Load $R_{thJS} = f(t_p)$

BCR169T

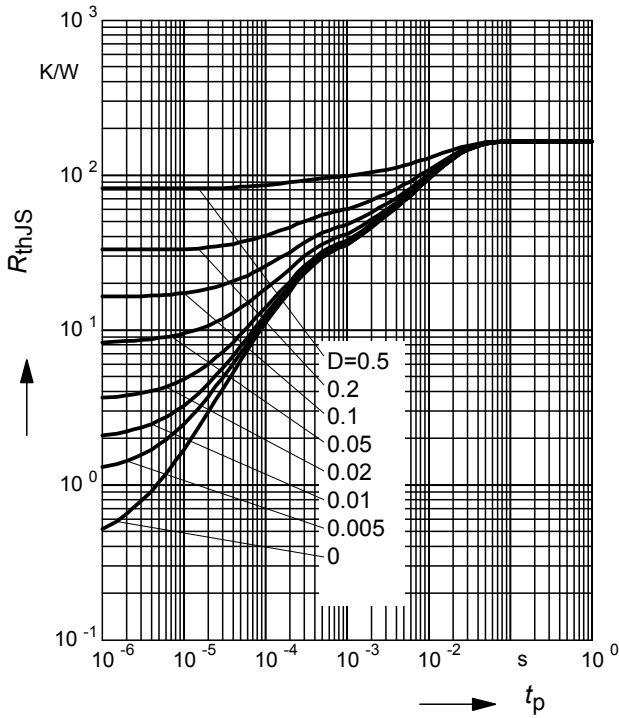

Permissible Pulse Load

$P_{totmax}/P_{totDC} = f(t_p)$

BCR169T

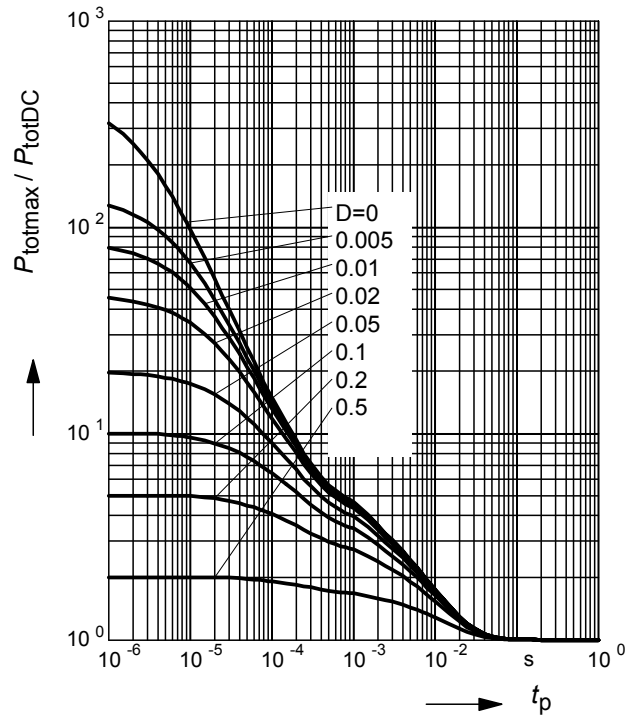

Permissible Puls Load $R_{thJS} = f(t_p)$

BCR169U

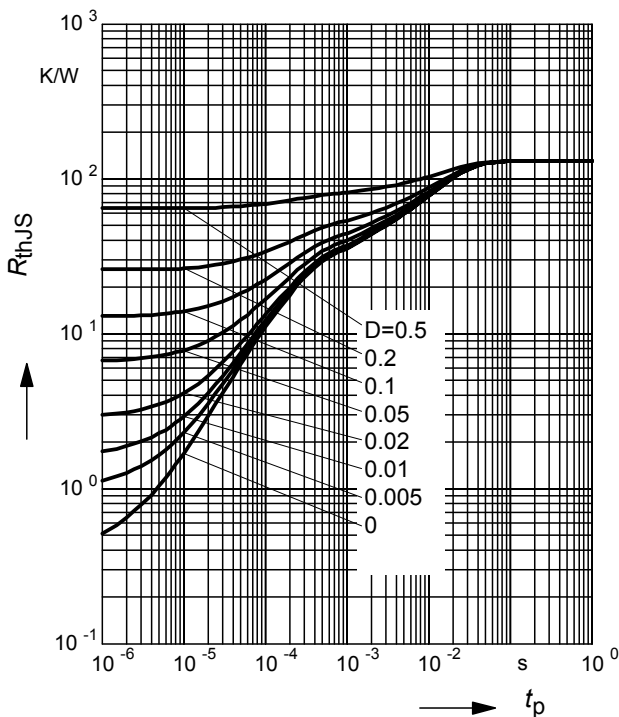

Permissible Pulse Load

$P_{totmax}/P_{totDC} = f(t_p)$

BCR169U

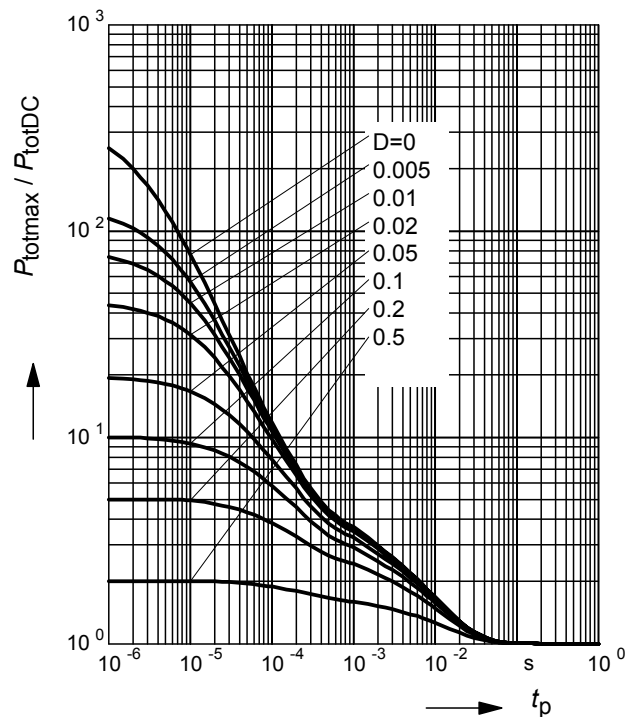

Permissible Puls Load $R_{thJS} = f(t_p)$

BCR169W

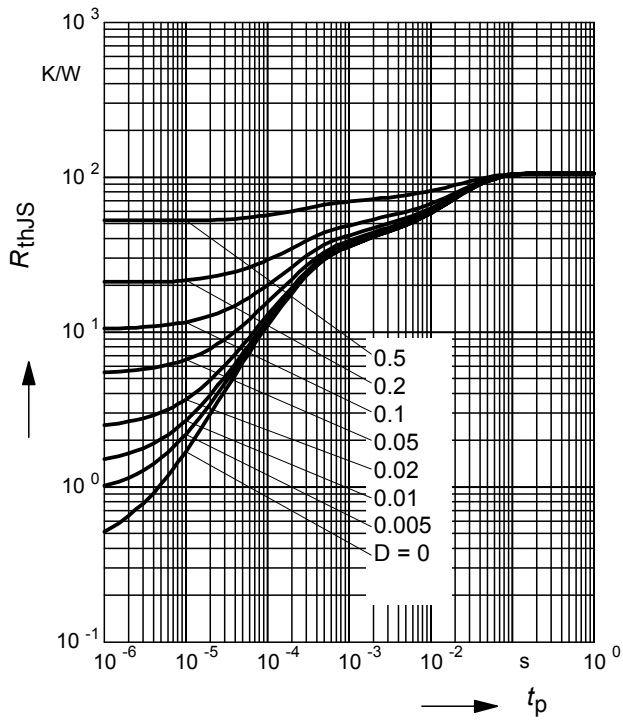

Permissible Pulse Load

$P_{totmax}/P_{totDC} = f(t_p)$

BCR169W

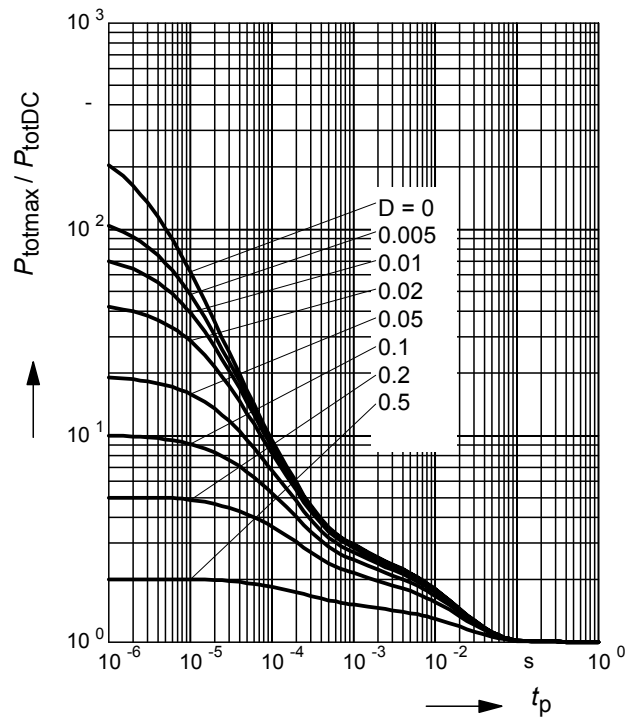

Package Outline

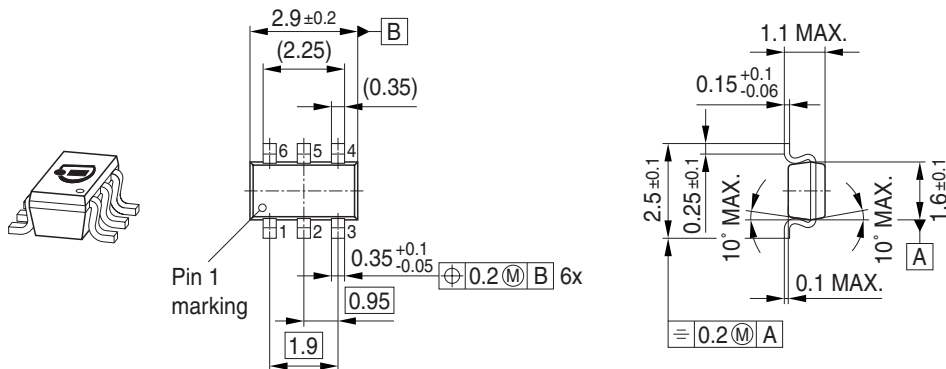

Foot Print

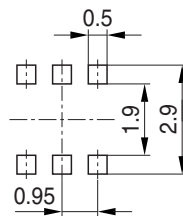

Marking Layout (Example)

Small variations in positioning of Date code, Type code and Manufacture are possible.

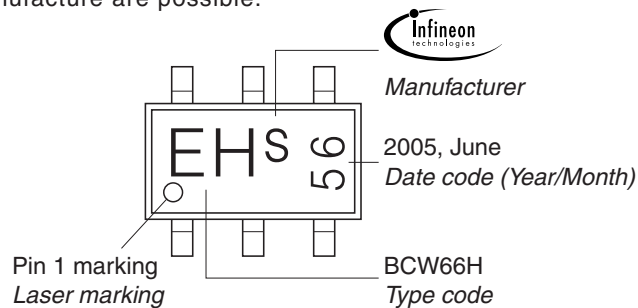

Standard Packing

Reel \varnothing 180 mm = 3.000 Pieces/Reel
 Reel \varnothing 330 mm = 10.000 Pieces/Reel

For symmetric types no defined Pin 1 orientation in reel.

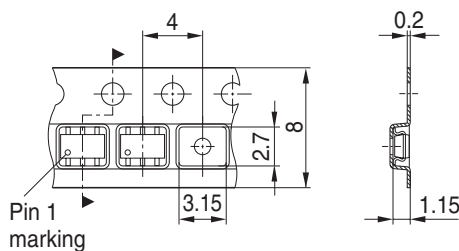

Package Outline

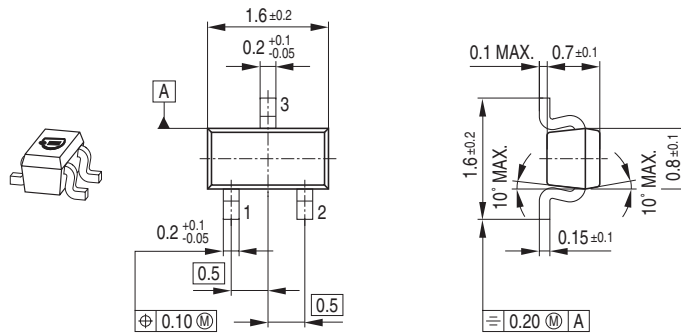

Foot Print

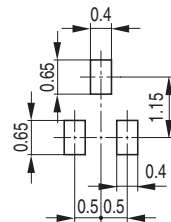

Marking Layout (Example)

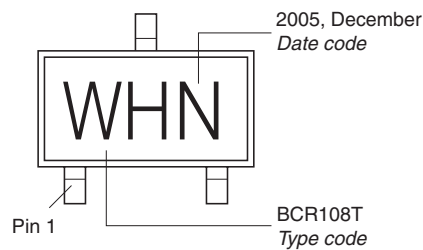

Standard Packing

Reel \varnothing 180 mm = 3.000 Pieces/Reel
 Reel \varnothing 330 mm = 10.000 Pieces/Reel

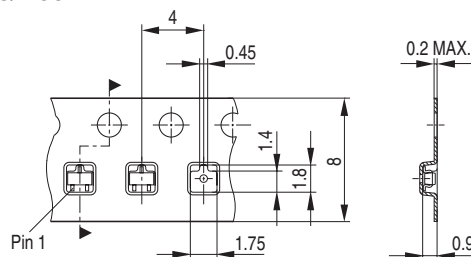

Date Code marking for discrete packages with one digit (SCD80, SC79, SC75¹⁾) CES-Code

| Month | 2003 | 2004 | 2005 | 2006 | 2007 | 2008 | 2009 | 2010 | 2011 | 2012 | 2013 | 2014 |
|-------|------|------|------|------|------|------|------|------|------|------|------|------|
| 01 | a | p | A | P | a | p | A | P | a | p | A | P |
| 02 | b | q | B | Q | b | q | B | Q | b | q | B | Q |
| 03 | c | r | C | R | c | r | C | R | c | r | C | R |
| 04 | d | s | D | S | d | s | D | S | d | s | D | S |
| 05 | e | t | E | T | e | t | E | T | e | t | E | T |
| 06 | f | u | F | U | f | u | F | U | f | u | F | U |
| 07 | g | v | G | V | g | v | G | V | g | v | G | V |
| 08 | h | x | H | X | h | x | H | X | h | x | H | X |
| 09 | j | y | J | Y | j | y | J | Y | j | y | J | Y |
| 10 | k | z | K | Z | k | z | K | Z | k | z | K | Z |
| 11 | l | 2 | L | 4 | l | 2 | L | 4 | l | 2 | L | 4 |
| 12 | n | 3 | N | 5 | n | 3 | N | 5 | n | 3 | N | 5 |

1) New Marking Layout for SC75, implemented at October 2005.

Package Outline

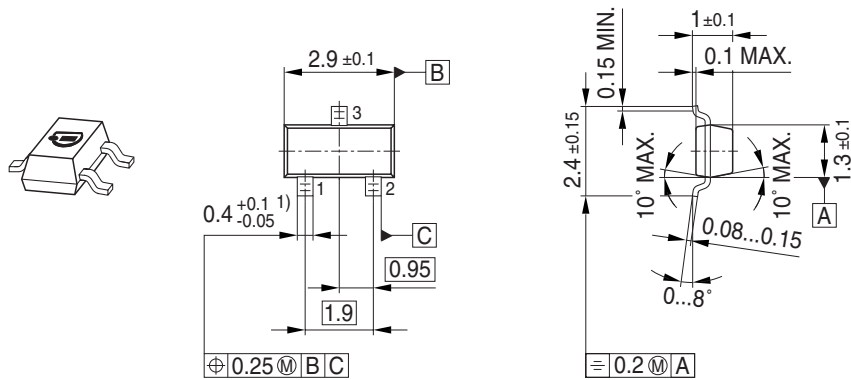

1) Lead width can be 0.6 max. in dambar area

Foot Print

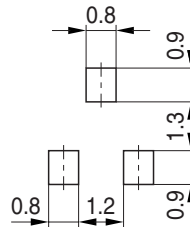

Marking Layout (Example)

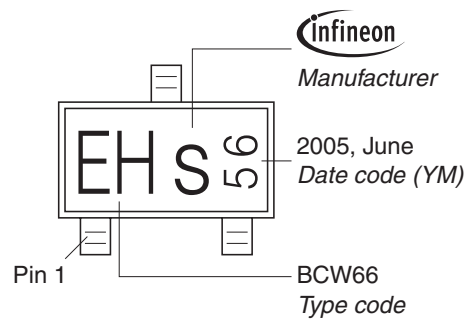

Standard Packing

Reel \varnothing 180 mm = 3.000 Pieces/Reel
 Reel \varnothing 330 mm = 10.000 Pieces/Reel

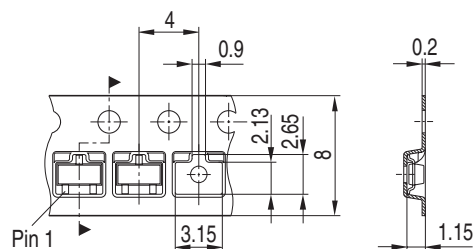

Package Outline

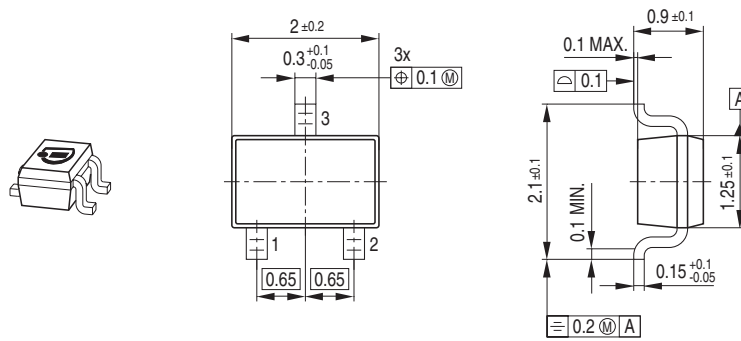

Foot Print

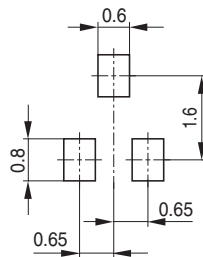

Marking Layout (Example)

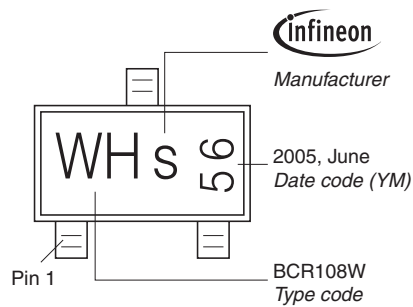

Standard Packing

Reel \varnothing 180 mm = 3.000 Pieces/Reel
 Reel \varnothing 330 mm = 10.000 Pieces/Reel

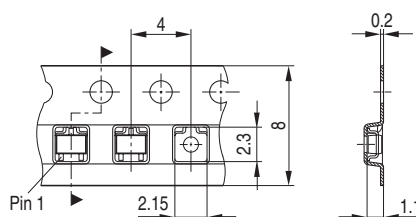

Package Outline

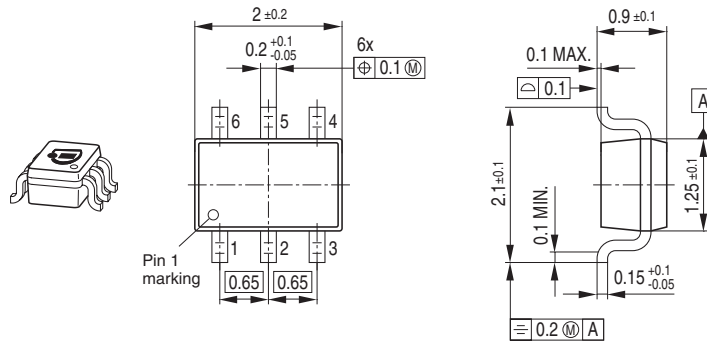

Foot Print

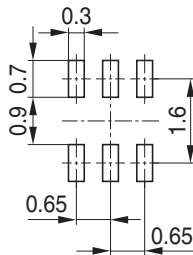

Marking Layout (Example)

Small variations in positioning of Date code, Type code and Manufacture are possible.

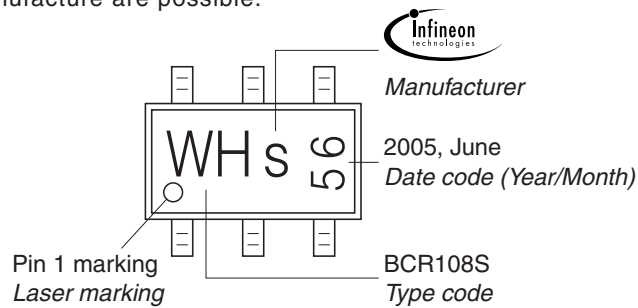

Standard Packing

Reel \varnothing 180 mm = 3.000 Pieces/Reel
 Reel \varnothing 330 mm = 10.000 Pieces/Reel

For symmetric types no defined Pin 1 orientation in reel.

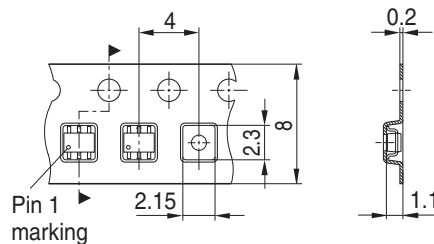

Package Outline

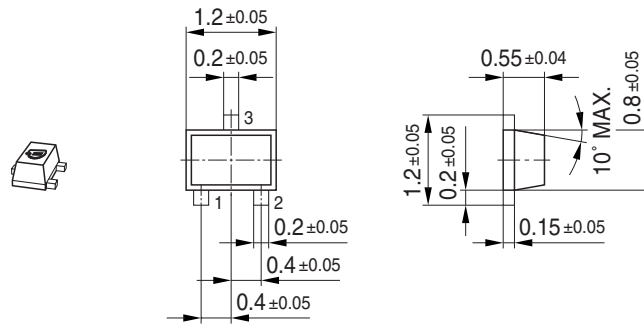

Foot Print

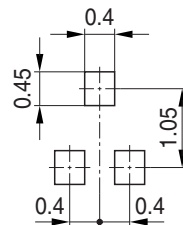

Marking Layout (Example)

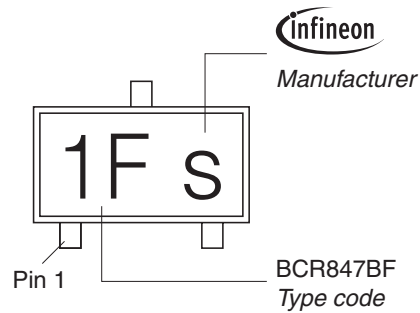

Standard Packing

Reel \varnothing 180 mm = 3.000 Pieces/Reel
 Reel \varnothing 330 mm = 10.000 Pieces/Reel

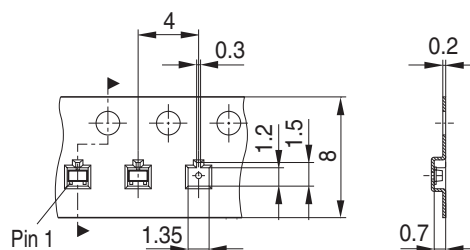

Package Outline

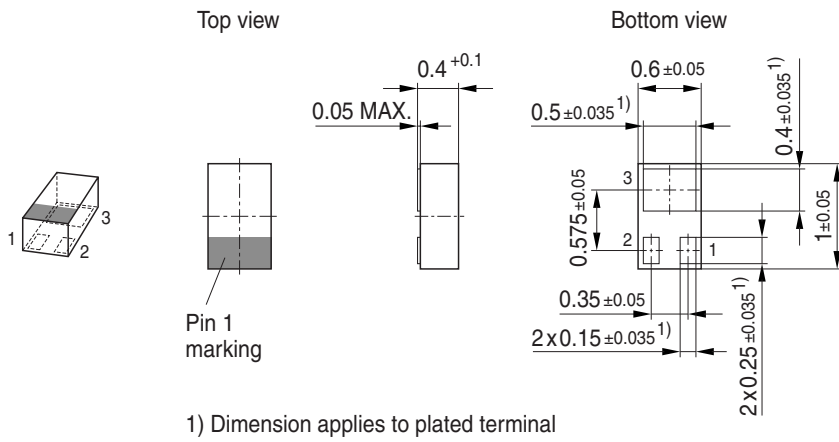

Foot Print

For board assembly information please refer to Infineon website "Packages"

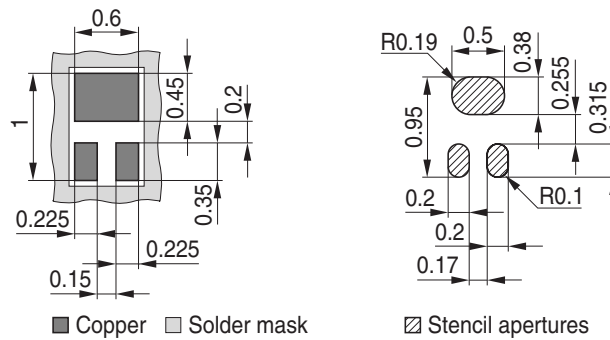

Marking Layout

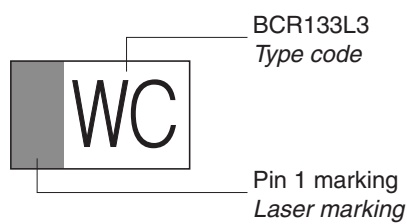

Standard Packing

Reel ø180 mm = 15.000 Pieces/Reel

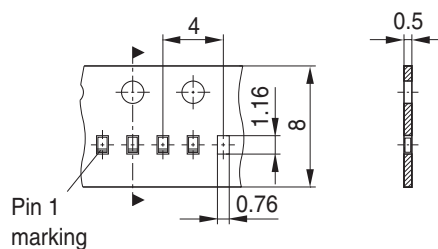

Edition 2006-02-01

Published by

Infineon Technologies AG

81726 München, Germany

© Infineon Technologies AG 2006.

All Rights Reserved.

Attention please!

The information given in this dokument shall in no event be regarded as a guarantee of conditions or characteristics ("Beschaffenheitsgarantie"). With respect to any examples or hints given herein, any typical values stated herein and/or any information regarding the application of the device, Infineon Technologies hereby disclaims any and all warranties and liabilities of any kind, including without limitation warranties of non-infringement of intellectual property rights of any third party.

Information

For further information on technology, delivery terms and conditions and prices please contact your nearest Infineon Technologies Office (www.infineon.com).

Warnings

Due to technical requirements components may contain dangerous substances. For information on the types in question please contact your nearest Infineon Technologies Office.

Infineon Technologies Components may only be used in life-support devices or systems with the express written approval of Infineon Technologies, if a failure of such components can reasonably be expected to cause the failure of that life-support device or system, or to affect the safety or effectiveness of that device or system.

Life support devices or systems are intended to be implanted in the human body, or to support and/or maintain and sustain and/or protect human life. If they fail, it is reasonable to assume that the health of the user or other persons may be endangered.